

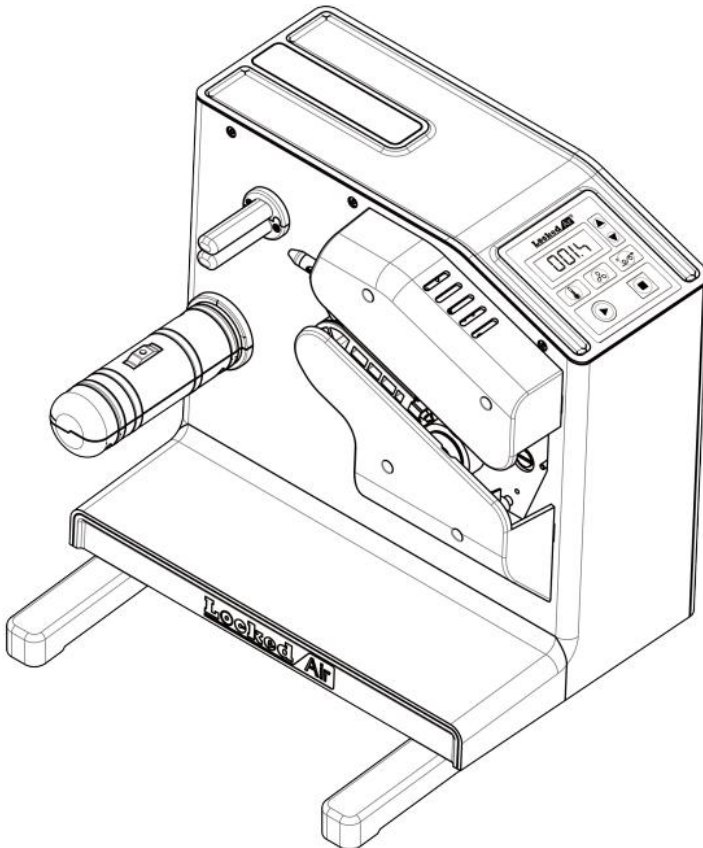

# Air Cushion Machine

## Operation Manual



Hangzhou Bingjia Tech. Co., Ltd.

## Abstract

Thank you for using lockedAir air cushion system. To ensure that you use the equipment correctly, be sure to read the instructions before you operate it!

**Note:** Operation of different models are slightly different, please pay attention to the tips mentioned below.

## Warning

- a. Power supply to machine must be consistent with the parameters on the machine nameplate, to prevent damage to the machine, please use only the power cable provided with the product.
- b. Make sure that the power cable is reliably grounded.
- c. Only trained person can open the back cover of the machine.

## Security Matters

- a. It is strictly prohibited to touch the high temperature warning area during the operation or within 5 minutes after the machine has been stopped.
- b. When the machine is working, do not touch any rotating parts.
- c. In the event of the following emergency, press the power switch quickly to cut off the total power supply of the machine.
  - The air cushion film or other material rolls into the machine and the machine does not work properly.
  - Abnormal sound inside the machine.
  - Abnormal heating, temperature on the plastic surface is too high;
  - Other exceptions

## 1. Main parameters of the device

Item #	Name	Parameters
1	Power	See details on nameplate
2	Rate	380W
3	Dimensions	300mmx360mmx345mm
4	Net weight	8.8kg
5	Working environment temperature.	0 to 40°C(32 to 104°F)
6	Working environment humidity.	20 to 90% RH

## 2. Operation Manual

### 2.1 Operating Procedures

#### 2.1.1 Power on

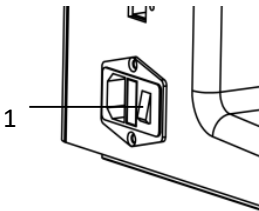

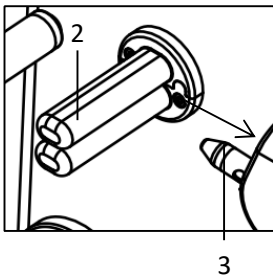

- Plug the power supply to a ground-protected single-phase three-wire socket.
- Turn on the power switch 1.

#### 2.1.2 Load the air cushion film



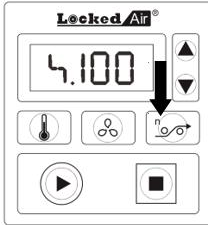
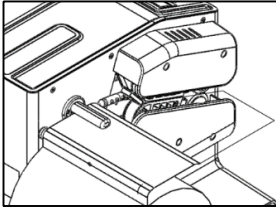

- Place the air cushion film on the mandrel, with the inflatable end close to the machine, lead the film through the middle of the 2 guide film rods(2), and then sleeve the air cushion film opening to the nozzle(3), drag the film toward the arrow direction to reach the gap between upper and lower heating belts



b. When the machine is in a stop state, press the loading button  to enter the film-loading mode, at this time the upper and lower belts will pull the air cushion film slowly forward to a certain distance and then stop automatically.



#### Tips:

- Long press the loading button , the heating belt will keep running until the button is released.
- When you press the start button  to start the machine, you will exit loading mode.

### 2.1.3 Parameter setting

Parameters Settings include temperature, air volume, speed and operating mode settings. In general, the parameters have been set before leaving factory. However, if you need to change the parameters, please refer to section 2.2 content.

### 2.1.4 Start and Stop







- Start** Press start button  and the heating wire heats up. This process lasts 5 ~10s, depending on the environment temperature. The device starts after the temperature reaches the set value.
- Stop** Press Stop Button , Machine Stops, Heating Wire cools down.

**Note:** Do not touch any high temperature area and rotating parts of the machine during operation or within 5 minutes after the machine stops.

### 2.1.5 Power off



- When the machine is in stop state, rip off the film close to the machine.
- Long press the film loading button  to drain the air cushion film that remains in the machine.
- Turn off power switch 1.

## 2.2 Control panel Instructions



Item#	Name.	Note.
1	Increase button	
2	Decrease button	
3	Film Loading	
4	Stop button	
5	Air volume button	
6	Start button.	
7	Temperature button	

### 2.2.1 Main interface.







The control panel displays as left picture when Power on. 001 represents the current preset parameters. In total 8 groups can be pre-set. Long press up button  or down button  for 3 seconds to change setting and the buzzer will beep 2 times.



Press the start button  the machine displays as the left screen,  indicating the current operating status. The machine will display  if machine stopped.





### 2.2.2 Set the temperature.



Press the temperature setting button  to enter temperature setting interface, where you can adjust the set temperature value by pressing the up  or down . Long press the  or  to continuously increase or decrease the set temperature value.







### 2.2.3 Set the air volume.



Press the air volume button  to enter the air volume set interface, Press the increase button  or decrease button  to adjust the set value. Long press  or  to continuously increase or decrease the set air volume value.





### 2.2.4 Set the speed.



Press the temperature set button  and decrease button  at the same time to enter speed setting interface, Press the increase button  or decrease button  to adjust the set value. Long press the  or  to continuously adjust the set speed value.



### 2.2.5 Timing model





Press the air volume button  and decrease button  at the same time to enter timing model, Press  to active timer and  or  to set timer period.

### 2.2.6 工程菜单介绍



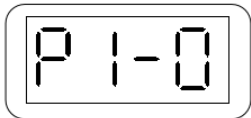

Short press temperature setting button 10 , enter temperature setting interface, long press temperature button 10  to enter the engineering mode.





In the engineering mode, press button 8  (P2~P1~turn) or  (P1~P2~turn), switch option:

#### **P1 is temperature compensated switch:**

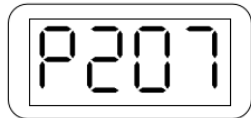
0-turn off, 1-turn on, default setting is turn off 0, Press  or  to modify; (When the machine needs to run for a long time, it is recommended to turn on this function)



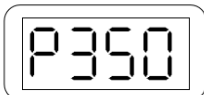

#### **P2 is motor stop time:**

Default is 7, press  or  to modify; (Note: No adjustment is recommended without professional guidance)



#### **P3 is for group 1 display temperature correction**

#### **P4 is for group 2 display temperature correction**

Correction range 0~99, Default is 50, press  or  to modify

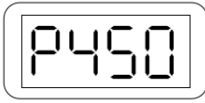

**Note:** actual temperature = display temperature + correction value -50

### 3. Fault analysis and diagnosis.

#### 3.1 Common faults and troubleshooting

Item #	Issue	Cause analysis	Suggested solution
1	Seal Leakage.	Heating temperature is too low.	Raise the temperature setting.
2	Seal area is thin and easy to tear.	Heating temperature is too high.	Lower the temperature setting.
3	The air volume is low.	The amount of wind is too small.	Increase the air volume setting.
4	Film break or film cut blurs	The blade is worn out.	Replace the blade.

#### 3.2 Fault Code Diagnostics.

E#	The fault code.	The cause of the failure.
1	F01-04	Blower abnormal
2	O02	Power alarm
3	H01,02,04,05	Heating abnormal
4	H03, H07	Temperature sensor abnormal
5	H06	Heating wire short circuit
6	H08	Heating control block abnormal
7	H09	Heating wire break
8	H10	The current of heating wire becomes smaller

Please contact an authorized dealer if the above fault code occurs.

### 4. Transportation and storage.

- Violent vibration or shock should be avoided during transportation.
- The machine shall not be exposed to rain
- Store in -25 to 55°C (-13 to 131°F) and humidity of less than 90% RH.

## 5. Appendix.

### 5. 1 Replace heating belts

#### a. Remove the upper and lower cover.

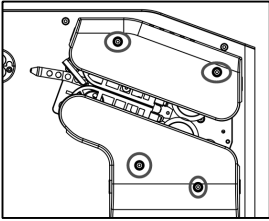

- Loosen the 4 screws located on the upper and lower covers with a 3mm wrench and remove the upper and lower covers (2 on the upper cover and 2 on the lower cover).

#### b. Lift the press wheel.

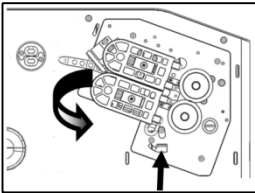

- Turn the lower heating wire assembly counterclockwise to the defined position and dial the pull ring clockwise to separate the two silicone wheels.

#### c. Replace and tropical.

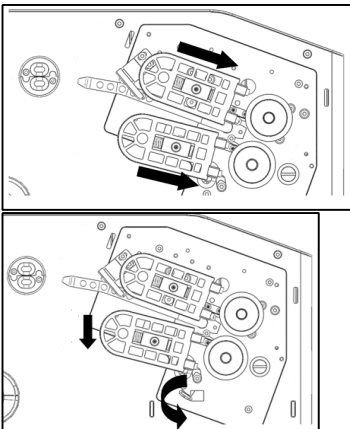

- Follow the arrow direction to push the upper heating wire mounting plate to the right, remove the heating belts from the right side, remove another heating belt in the same way.
- Load the new heating belt from the left and press to the heating belt block to install the heating belt. Install another one in the same way.
- Push lower heating wire assembly along the direction of the arrow to loosen the pull ring, dial the pull ring to reset the lower heating wire assembly

#### d. Install the upper and lower cover



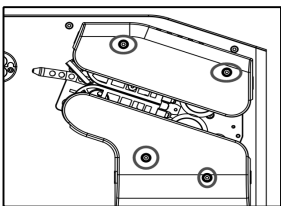

- Use a 3mm hex wrench to install the upper and lower cover with the 4 screws.

## 5.2 Replace the blade

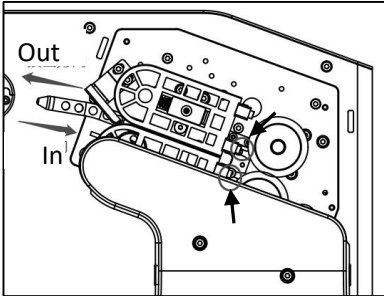

- Loosen the blow nozzle fixing screw (no need to fully unscrewed), holds the end of the nozzle to pull it out in the direction of the arrow.
- Remove the blade screw, replaces the new blade (the blade is facing outwards), and tight the blade with screw (**Caution: Not to be cut by the blade**).
- Push nozzle to the right in the direction of the arrow until the nozzle cannot move, fix the assembly with screw.

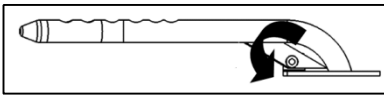

## 5.3 Replace the high temperature adhesive tape.

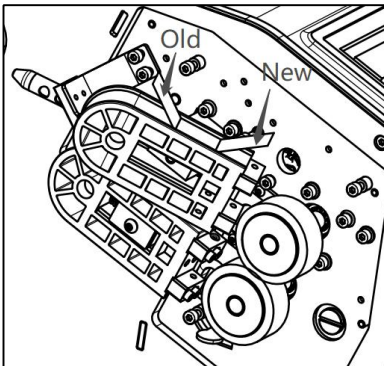

- Remove the heating wire assembly, be careful not to lose the small spring.
- Turn the upper heating wire assembly out for an angle to replace the adhesive cloth.
- Tear off the original high temperature adhesive tape by a part and then apply the new tape.